

Use of Artificial Intelligence Methods in Ship Design

G.A. Amil Dilshan Perera
Faculty of information Technology
University of Moratuwa
Sri Lanka

K.A. Dilini T. Kulawansa
Department of Computational Mathematics
University of Moratuwa
Sri Lanka

Abstract- Interest has entire in investigating Artificial Intelligence (AI) methods to design issues and problems in past years, for the huge possible impact on productiveness of developed design equipment and the absorbing basic Artificial Intelligence issues. AI is a surface of computer science and technology that emphasizes the production of intelligent various machines that react and work as humans. Learning, Planning, Speech Recognition and Problem-Solving activities are designed by the AI today. This research paper focuses on various ways of incorporating AI, Component Based Reasoning (CBR), Fuzzy Logic, expert systems and neural networks relational database aided ship design.

Key words- Artificial Intelligence, Component Based Reasoning, Expert systems, Neural networks, Fuzzy Logic

I. INTRODUCTION

Research allied with AI is highly specialized and technical. The focus problems and matters of artificial intelligence incorporate programming computers for certain and specific traits such as reasoning, perception, learning, knowledge, problem solving, planning and ability to manipulate and move objects. Knowledge engineering is a focus part of Artificial Intelligence research [1]. Machines can frequently act and react as humans only if they have generous information interrelating to the world. AI must have access to properties, objects, categories, and connections between all of them to achieve knowledge engineering [2]. Introducing reasoning, common sense and problem-solving energy in machines is a tedious and difficult task.

The problems equivalent with scaling implicate challenging and active research points in the surface of AI. Artificial Intelligence will be used to find the solutions for specific problems. In the subject issue literature examples of application of AI to ship design can be proved, especially to its introductory state when ship's main limits are selected on the foundation of ship owner's design ideas. The main purpose of the Artificial Intelligence techniques in ship design is to create cost-

effectiveness, flexibility, accuracy, speed and user-friendliness ships. Ship design includes a number of AI techniques aimed on general guidelines of deduction and decision-making operations relevant for the solutions.

In order to guarantee optimum main sizes for a ship while it designing the technique, which, includes in looking ships of same characteristics and modifying the selected design products, is frequently applied. To use intelligence dealing with previous developed same designs is possible for both Case Based Reasoning (CBR) technique which makes designing a ship of high capability faster and easier and neural networks which can be guided on the foundation of representative examples and results concluded from other sources. Thus, the details processing characteristic for conventional expert systems may be supposed complementary to the scattered parallel processing normal for Neural Networks. Both traditional AI tools simultaneously with a relational database were applied for the work instantly.

II. OVERVIEW OF NEURAL NETWORKS, FUZZY LOGIC AND PSO ALGORITHM

We can further categorize the overview section into three subheadings such as neural networks, fuzzy logic and PSO algorithm.

A. NEURAL NETWORKS

Neural Network is an information-processing pattern that is motivated by the human brain. To ease the resolution of the main features of a ship at the basic design step it is suitable to have equipment which [4], given the model of ship and some other values and the parameters, expenditure estimations of the continuing ranges. To authorize such a device, a database of the attributes of about 88,000 ships is accomplished and various techniques for inception of provisional relations are employed [3]. A retrogression analysis is transferred out to fit purposes to the data. The data are used to learn

neural networks to encode the dependences between the attributes. On the foundations of examples, there are three methods evaluated in terms of limitations and accuracy of use. The methods supply information on the dependences between height, length, draft, breadth, displacement, speed, loading capacity and block coefficient for different types of ships. Therefore, useful devices are usable to the designer when he or she selects the primary main attributes of a ship [5].

B. FUZZY LOGIC

Fuzzy Logic is a technique of intelligent that corresponds human reasoning [10]. The purpose of Fuzzy Logic reproduces the way of conclusion making in humans that implicates all intermediate occasions between digital values 'NO' and 'YES'. In Fuzzy Logic this research paper mainly focuses on ship propulsion system. Ship propulsion is not just about fortunate movement of the ship in the water [11]. It also incorporates using the best condition of propulsion to assure a better security standard for the marine ecosystem forward with cost proficiency by using Fuzzy Logic.

C. PSO ALGORITHM

Pointing at favourable design of hull form related on Simulation Based Design (SBD) technology [14], a new neural network equivalent technique is introduced. First, through applying Particle Swarm Optimization (PSO) algorithm training Flexible Radial Basis Function (FRBF) neural network emphasises, PSO-FRBF neural network algorithm is introduced. By analysis and comparison of the wave resistance coefficient of various methods, superiority and applicability of the new algorithm is verified. Then, Wrigley hull is taken as pattern, with the parameters and principal proportions as design variables, and the total endurance optimization pattern is established through conducting PSO-FRBF wave endurance coefficient approximation pattern [12]. After the Simulated Annealing Algorithm (SAA) is used in the ship hull ideal design, and a reasonable and reliable optimized ship hull is achieved. The new neural network can supply fine technical help for applicable ship optimization design step.

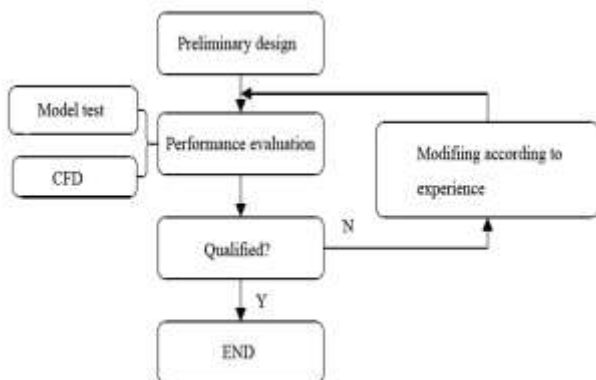

Figure 1: Traditional Ship Hull Design Pattern
 The ship hull optimization designed based on Simulation Based Design shown in **Figure 2**.

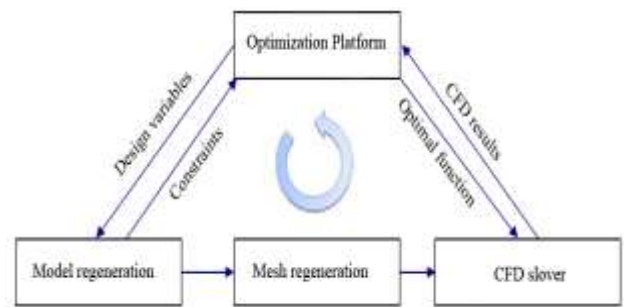

Figure 2: Ship Hull optimization designed based on SBD

RBF (Radial Basis Function) neural network that directly and mainly mentioned Biological Local Regulation (BLR) and overlapping recognition of regional comprehension is kind of (ANN) Artificial Neural Network which performed local reception surface for completing the function mapping [13]. The primary structure of RBF is presented as a three level provide forward network, that containing hidden, input, and output layers.

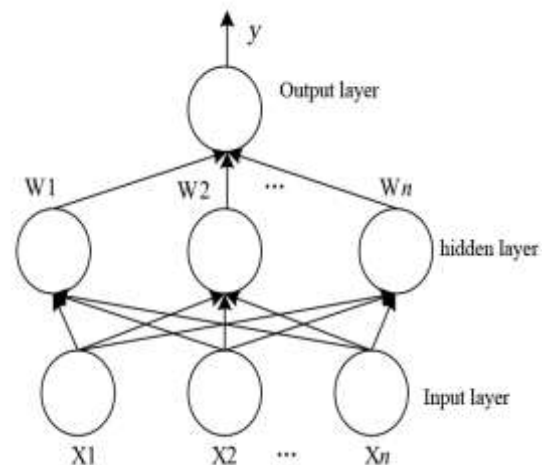

Figure 3: Radial Basis Function Neural Networks

III. MAJOR REASERCHES OF ARTIFICIAL INTELLIGENCE METHODS IN SHIP DESIGN

Different researches were executed to identify the suitability of Artificial Intelligence to shipbuilding and design. In this research paper, this part is mainly emphasizing on researches that have previously been done.

A. Fuzzy logic-based design of Main ship Propulsion System (MPS)

The aim of design of ship MPS is bring out by practicing the probability calculations involved in fuzzy logic method fixed in expert systems, as well as database applications [9]. Fuzzy logic can be used concurrently to any number of variables or parameters. It makes it potential to deliver from numerical values for quantities to grammatical ones at which logical thinking can be simply achieved [7]. The litigation this path becomes unconstrained of a scope of numerical estimations or values of observed parameters, show in Fig 1.

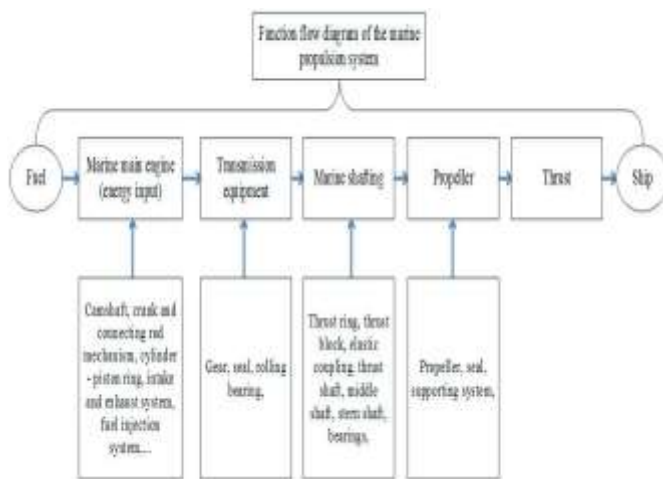

Figure 4: Numerical estimation of Ship propulsion system

B. Artificial neural network to the acceptance of a maximum proficiently ship screw propeller

The object of the current attention is to use the benefits of the neural networks through selections of a maximum ship screw propeller as a preface to more complicated ship design issues. Neural network was produced and make ready to supply the features of the maximum proficiently propeller [11]. To make ready the network, accelerate speed, data estimating the blade number, rate of overthrow, distributed power, pitch ratio, diameter, propulsion and efficiency were arranged as outputs and inputs as well as expanded surface ratio [3]. The checking of the network showed it's proficiently, which performs it an efficient tool for the preparation screw propeller acceptance.

C. Ship hull form transformation on propulsion features based on AI and ship resistance by CFD

On the element of justified contingency of obtainable programs of computer, voluble system was selected to

analyze concentrated flow about ship hull [6]. The acceptance of voluble system has been mostly absolved by its extended computational capacity of ship hull. Ship hull model and the numerical computational griddle have been studied on the foundation of 2D drawing models of bodylines [8]. The 3D models aimed on it may out modify to one another, in such different tests 3D ship hull models could be willingly used. Efficiency of numerical calculations can be persuaded by categorize of computational griddle, number of computational range factors as well as other values and parameters or dimensions of computational fluid dynamic methods (CFD), could be further compared [15]. The ship endurance numerical calculation was applied for the accepted ship onward it is possible to investigate whether for other ship hull frames same relations could be obtained.

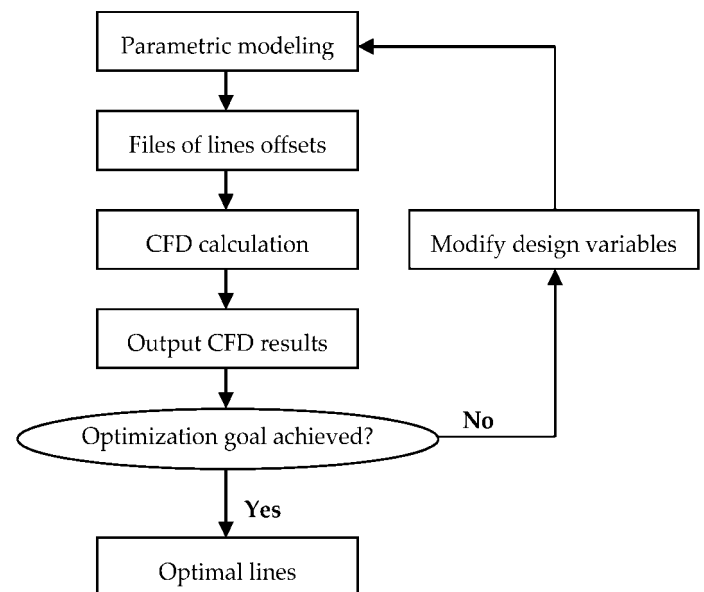

Figure 5: Ship hull modeling by CFD

D. Ship Hull Optimization

On overall ship design process, ship conception model design is on the top. [16] Around the evaluation and creation of ascends of projects or extends; the best project standard can be gathered. Development of marine ship optimization design contributes the aspect platform for the ship-integrated model. As the basis, optimization design can be combined relevant optimization algorithm for achieve mounts of project works from fixed design area, then linking evaluation method and the optimal design architecture control can be rapidly complete for further complicated design.

Ship Hull Optimization based on neural networks

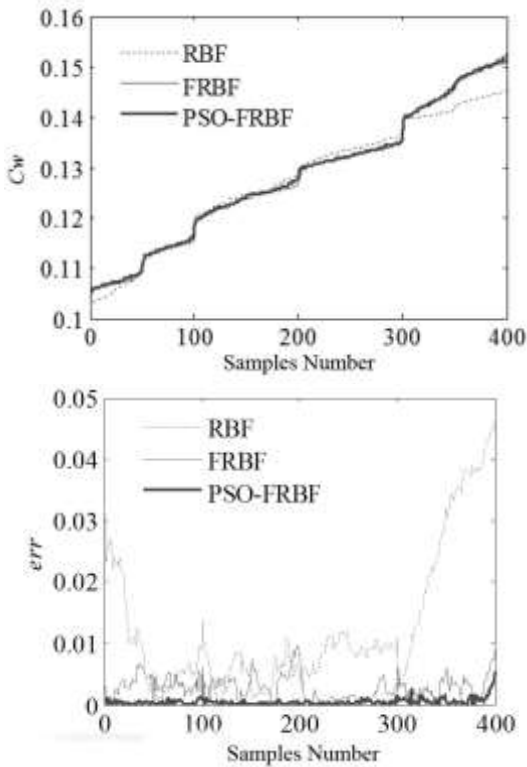

Figure 6: Test result comparison and Test result error comparison

Ship optimization design is passed down as the basic development in step of marine ship approach design and project work assessment, which backing the evaluation software design and spiral design. [19] It is collected by the comprehensive achievement evaluation section, investigation of the project's feasibility-investigating section, evaluation section (including evaluation of adaptability, cost and risk), that the group of sections includes the data pairing accord. [21] Optimization design takes the design pressure and the prime system projects as input, and marine ship projects, that are assert by a sequence of, design volatiles as output.

The optimal actions accommodate these basic technologies: quick establishment of ship projects placed on optimization algorithm technology, formulation technology of specific ship optimization design, and the technology of different projects evaluation [20]. Between these various technologies, optimization design formation needs arise of the experimental data plus actual ship test growth, and copious optimization design library has developed since the evolution of unified design approach for more than a century [22]. Accordingly, the two basic technologies are disturbed here and research will be done from evaluation algorithm and intelligent optimization after.

E. Ship Decision-Support System (SDSS)

There are number of ship man-machine systems in present, which clarify control projects in emergency circumstances, overbearing that all isolated authority channels are accurately running. But that it was controlled previous, the modern vessel is a multi-unit item [17], components of that can be handicapped with a huge amount of probability (due to fire damages, failure of equipment or flooding of carriage etc.). Therefore, the preferred of the best determination to insert vessel deficient emergency position (the danger of concussion with a conflicting ship is an example) doesn't have to build upon extraneous aspects only (guidance of current and velocity, wind, conflicting traffic etc.) [23]. Decisions are managed integrates of the item (rudder angle, velocity, heading) and outcomes of working strengths analysis of all the systems sophisticated into a supervision process are affecting by other items.

Human-engineer itself cannot appliance the project in general [18]. The reason is all essential and difficult decisions need to be reasoned and made through a computer, although leaving or balancing for a human-engineer the final determination "to do or not to do" a maneuver or an action. Therefore, Fuzzy Determination models based on decision support system is introduced for this section. Such decision support systems will grant us to manage the multi-unit objects in acute conditions, catching through to sudden damages of detached mediums, determined by technological and technical analysis algorithms placed on fuzzy-set theory [24]. **Figure 7** presented the structure of digital SDSS. The decision support system supports to get multi-principle explanations in acute conditions. Decision Support Unit (DSU) is the main frame of the entire system and it solves the following duties.

- Recognition and analysis of damages in constituent of the composed object.
- Estimating of object performance in acute conditions.

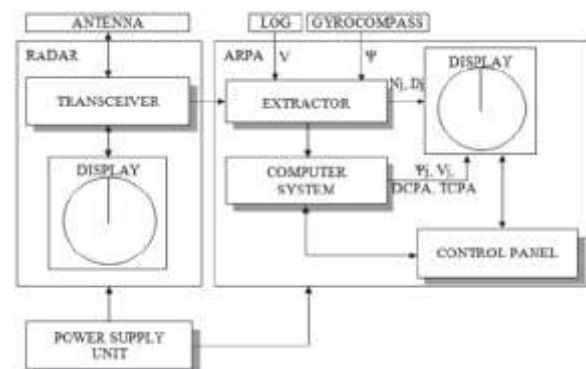

Figure 7: The structure of digital Ship Decision Support System

IV. CHALLENGES OF ARTIFICIAL INTELLIGENCE METHODS IN SHIP DESIGN

A specific or a unique ship design issue provided a concrete basis although clarifying methods, concepts across disciplines and introducing specific ideas and concepts about Artificial Intelligence approaches. AI approaches and technologies bring both risks and opportunities in the ship design section.

Introduction of new ways and technologies of working brings along modified and new safety risks in shipbuilding and design such as increasing system complexity is a major challenge in ship design.

New connections between machines and human, and Lack of distance standards increases the technology developers' obligation for affirming safety [12]. The basic challenges in Artificial Intelligence based ship design shown in *Figure 8*.



Figure 8: The basic challenges in Artificial Intelligence based ship design

V. APPLICATIONS OF ARTIFICIAL INTELLIGENCE BASED SHIP DESIGN

A. CARGO SHIPS

Japanese ship building companies need to design self-maritime navigating cargo ships [13]. Working abreast ship designers, their aim is to increase new technologies, methods that can envision malfunctions, decrease maritime accidents and improve accuracy and efficiency. The cast is to accomplish an Artificial Intelligence driven steering combination or a system that could set out the safest, shortest and more fuel-efficient paths based on facts like weather and any obstructions that impetus be in a ship's way. Cooperating companies have compromised to accord both costs and expertise. They hope to manufacture around 260 ships with new technologies. Finally, the companies focus to accomplish completely thesaurus shipping at some position in the future.

Japanese groups are not the only ones manufacturing autonomous cargo ships [7].

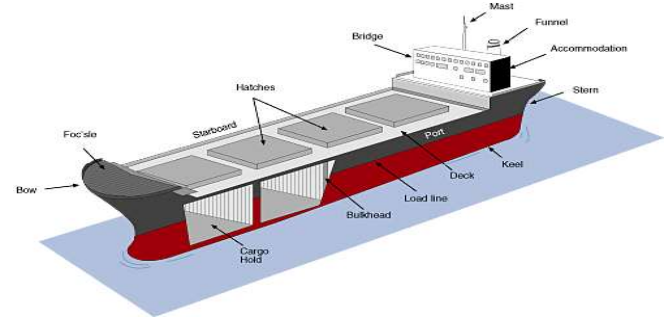

Figure 9: Cargo ship

B. ICE CLASS CONTAINER SHIPS

All ships are not manufactured to an ice class. Manufacturing a ship to an ice class defines that the hull should be thicker, and much scantlings (accumulate of girders, bulkheads and beams resulting in powerful structural perfection) should be in place [4]. Sea chests (expanding in the ship hull for seawater inlet) may want to be organized differently hanging on the evaluation. Sea bays can also be required to guarantee that sea chest doesn't become obstructed with ice. Most of the stronger sections need several forms of propeller and rudder preservation. Two impolite pintles are normally needed, and empower propeller tips are frequently needed in the powerful ice classes [8]. Also, watertight bulkheads in accession to those needed along with a ship's prevalent class are normally required. Addition, heating adaptations for ballast tanks, fuel tanks, and other various tanks energetic for the ship's control might also be needed hanging on the class.

VI. CONCLUSION

The intended outcome of this study is to identify the uses of artificial intelligence methods in ship design and its most variable and practical research works and techniques in the field of control. Artificial Intelligence found comparatively new technologies in the shipbuilding field of maritime engineering architecture. They maintain the features that create them specifically interesting in complex problems. This study mainly focuses about the most suitable and reliable mechanisms in the ship designing and the shipbuilding field. Even for the new technologies of artificial intelligence are multifaceted and vast this study considered on that willingly under developed area of these technologies. This research paper has been written by regarding to journal articles, twenty-five research articles and conference papers. Findings of the researches can be summarized as follows.

TABLE I. SUMMARY OF RELEVANT REASERCHES

No	Paper Title	Aim & Problem addressed	Findings
1	On application of some artificial intelligence methods in ship design.	Identify the errors of selected intelligence technologies of shipbuilding.	Neural networks, Expert systems, Relational Databases.
2	Artificial Intelligence and Marine Design and Data Security in a Ship Detection, Identification System and An Information System for ship detection and identification.	Provide a concrete basis for clarifying concepts and methods across disciplines; identify the ships purpose, presenting specific ideas about AI approaches and future development.	Advanced computational approaches, Ship detection, Data security, SDIS, System security, Ship detection and Identification.
3	Shipbuilding practice and ship design methods from the Renaissance to the 18 th century.	Review recent findings and to discuss novel methodologies about ship structural design.	Hydrostatics and Stability, hull geometry, Ship motions, manoeuvring and propulsion.
4	Risk-Based Ship Design and Ship behavior recognition based on infrared video analysis in a maritime environment.	Presents modern risk-based methods, operation, regulations and introduces the ship behaviour perception algorithm.	Neural networks, Component Based Reasoning (CBR), Ship behavior, Intelligent perception.
5	Development of software for computing forming information using a component-based approach	Introduce new frameworks for create ship hulls.	Thermal forming, CBD, Software architecture, Forming information, Automation, Ship fabrication.

6	Numerical analysis of control of ship hull form modification on ship resistance and propulsion characteristics.	Determination of ship speed, propulsion engine power for the designed ship and propeller rotational speed.	Ship hull geometry, (CFD), resistance, wake, and propeller efficiency.
7	Application of artificial neural networks to assessment of ship maneuverability qualities, Ship Hull Optimization Based on New Neural Networks and Net Based Waterside Security Applications From small solutions to maritime security networks.	Applying neural networks for assessment of parameters of standard maneuverability tests, pointing at optimization design of SBD and Describes about databases for waterside control and several sensors.	Neural networks, Ship maneuverability qualities, PSO algorithm, FRBS neural network, Hull form optimization, Net based Operations, Data Fusion, Harbor Protection.
8	Computation of the inviscid drift force caused by nonlinear waves on an immersed circular cylinder.	Computing and calculating the higher-harmonic components of the transmitted wave.	Transmitted wave, Higher-harmonic component, Numerical wave tank, Nonlinear potential flow,
9	A survey on knowledge-based systems for ship design, Knowledge-Based Vessel forecast Position using Historical AIS Data and Results of Measurement Campaign for Characterization of AIS Transmitters.	Describes KBS based ship design and ship operation over the past three decades. Identify the probability to incorporate and developed services in maritime area.	Hull geometry, Particle filter, AIS, Transmitter and signal characteristics.

10	Thermal distortion analysis method for TMCP steel structures using shell element.	Development of an algorithm, which could calculate inherent strain.	TMCP steel, Thermal falsification analysis, Inherent strain, Finite fundamental method, Shell element.
11	Vertical axis turbine for tidal flow energy conversion and Unsteady flow around two-dimensional sections.	Using a computational fluid dynamics (CFD) tool solving the Reynolds-Averaged Navier-Stokes equations.	Tidal Stream Energy Conversion; Vertical Axis Turbine; Computational Fluid Dynamics.
12	Fuzzy Approach for design of ships decision-making system.	Identifying the evolution of systems for determining of ship performance in unclear unstable environments and a SDSS for navigating in circumstances of narrow places.	Fuzzy tests, SDSS, Prognosis, Approximation, Identification.
13	AIS-based analysis of ships' routing system.	Determines AIS based Ships' routing system that supplies useful awareness about difficult naval transportation routes.	Maritime control, Ship routing, Traffic stress model.

VII. FUTURE DIRECTIONS OF ARTIFICIAL INTELLIGENCE METHODS IN SHIP DESIGN

Important researches of new technologies in AI based ship designing and manufacturing is increasing rapidly. Artificial intelligence could finally produce most proper solution for shipbuilding. Details of research working of future directions are mentioned before.

In explanation to the attention in this area, the Defense

Advanced Research Projects Agency (DARPA) introduced a workshop onwards-marine design and Artificial Intelligence and it held at Rutgers University in New Brunswick, 1989 [2]. The workshop was contracted to accommodate planning advocate for investigation in the tolerant area of unconventional computational converges to design, including special significance on the research of Artificial Intelligence methods and techniques in hydrodynamic ship design.

The workshop is responsible for two goals. First goal is absorbed AI based research issues and specifying relationships among issues in hydrodynamic ship design. More especially these interrelated to the analysis and design of more complex systems, conciliating communications and supporting establish accordance between marine designer-analysts and Artificial Intelligence researchers. Second goal involved assessing and formulating unique issues in the area of marine design that are consequential for ship designer-analysts.

Improvements of current AI approaches based on neural networks, fuzzy logic, CBR and expert systems that do predictions such as recovering more methods that is applicable for decreasing the contention. AI will provide more powerful, possible and positive decisions and it will help to build more safety ships.

ACKNOWLEDGMENT

Expanding and describing areas in a research are not easy tasks. I would like to offer my gratitude to my colleagues for encouraging me to conduct this research. Many thanks to my family for always being my strength, showing me the correct path, and making me who I am today.

REFERENCES

- [1] Maria Meler Kapcia, Stefan Zielinski, Zbigniew Kowalski, On application of some artificial intelligence methods in ship design, Gdansk University of Technology, November 2005.
- [2] Saul Amarel and Louis Steinberg, Artificial Intelligence and Marine Design, Computer Science at Rutgers University, November 1990.
- [3] Horst Nowacki and Matteo Valleriani (Eds.). Shipbuilding practice and ship design methods from the Renaissance to the 18th century, Max Planck Institute for the History of Science, November 2003.
- [4] Carlos Guedes Soares, Andrzej Jasionowski, Jorgen Jensen, Dag McGeorge, Apostolos Papanikolaou, Risk-Based Ship Design, National Technical University, August 2009.

- [5] Volker Bertram, A survey on knowledge-based systems for ship design, AGL Company, August 2013.
- [6] Tadeusz Szelangiewicz, Numerical analysis of influence of ship hull form modification on ship resistance and propulsion characteristics, West Pomeranian University of Technology, 2009.
- [7] Tomasz Abramowski, Application of artificial neural networks to assessment of ship maneuverability qualities, Szczecin University of Technology, 2008.
- [8] Jin Kim, Kwang-Soo Kim, Yoo-Chul Kim, Suak-Ho Van and Hyo-Chul Kim, Comparison of potential and viscous methods for the nonlinear ship wave problem, Korea Ocean Research & Development Institute, Daejeon, Korea Department of Naval Architecture and Ocean Engineering, Seoul National University, 2013.
- [9] Hyeok-Jun Koh, Il-Hyoung Cho, Computation of the inviscid drift force caused by nonlinear waves on a submerged circular cylinder, Multidisciplinary Graduate School for Wind Energy, Jeju National University, Jeju, Korea Department of Ocean System Engineering, Jeju National University, 2013.
- [10] Kwang Hee Ko, Jung Seo Park, Jung Kim, Young Bum Kim, Jong Gye Shin, Development of software for computing forming information using a component-based approach, Seoul National University, Seoul, Korea Research Institute of Marine Systems Engineering, Seoul National University, Seoul, Korea, 2013.
- [11] Hyun-Kyoung Shin, Byoung-Cheon Seo, Jea-Hoon Lee, Experimental study of embedding motion and holding power of drag embedment type anchor on hard and soft seafloor, School of Naval Architecture and Ocean Engineering, University of Ulsan, Korea 2013.
- [12] Young Joo Song, Jong Hun Woo, Jong Gye Shin, Research on a simulation-based ship production support system for middle-sized shipbuilding companies, Research Institute of Marine Systems Engineering, Seoul National University, Seoul, Korea 2013.
- [13] Young-Joo Song, Jong-Hun Woo, Jong-Gye Shin, Research on systematization and advancement of shipbuilding production Management for flexible and agile response for high value offshore platform, Department of Naval Architect and Ocean Engineering, Seoul National University, 2013.
- [14] Yunsok Ha, Rajesh S.R., Thermal distortion analysis method for TMCP steel structures using shell element, Samsung Heavy Industries Co., LTD, 530 Janpyeong-dong, Geoje, 656-710, South Korea, 2012.
- [15] Hyun Ju Jung, Ju Hyun Lee, Shin Hyung Rhee, Museok Song, Beom-Soo Hyun, Unsteady flow around a two-dimensional section of a vertical axis turbine for tidal stream energy conversion, Research Institute of Marine Systems Engineering, Seoul National University, Seoul, Korea, 2013.
- [16] Yuan-Hang Hou, Xiao-Jing Jiang, Xiong-Hua Shi, Ship Hull Optimization Based on New Neural Network, College of Transportation Equipment and Ocean Engineering, Dalian Maritime University, Dalian, China, April 2016.
- [17] Kondratenko Y.P., Kondratenko G.V., Pidoprigora D.M., Sidorenko S.A., Timchenko V.L, Fuzzy Approach for design of ships decision-making system, Ukrainian State Maritime Technical University, National Kiev-Mohila Academy, November 2013.
- [18] Zhanghao, Xiaoyingjie and Yangxiaojun, AIS-based analysis of ships' routing system, Merchant Marine College Shanghai Maritime University Shanghai, China, April 2009.
- [19] Rolf Muller, Chris Brook, Net Based Waterside Security Applications From small solutions to maritime security networks, ATLAS Electronic GmbH Bremen, Germany, August 2004.
- [20] Bustanul Arifin, Edward Ross, Yuval Brodsky, Data Security in a Ship Detection and Identification System, Satellite Bus Department Indonesian Space and Aeronautics Institute Bogor, Indonesia, June 2013.
- [21] Edward Ross, Bustanul Arifin, Yuval Brodsky, An Information System for ship detection and identification, Gemini Innovations North Saanich, Canada, August 2008.
- [22] Nicolas Bouny, Julia LeMaitre, Jean-Pierre Millerioux, Results of Measurement Campaign for Characterization of AIS Transmitters, 26 Rue du Soleil Levant 31410 Lavernose-Lacasse, France, 2012.
- [23] T.Gaggero, I. Karasalo, T. Folegot, L. Six, M. van der Schaar, Validation of a simulation tool for ship traffic noise, University of Genoa, Genoa, Italy.
- [24] Fabio Mazzarella, Virginia Fernandez Arguedas, Michele Vespe, Knowledge-Based Vessel Position Prediction using Historical AIS Data, European Commission - Joint Research Centre (JRC), Institute for Protection and Security of the Citizen (IPSC).
- [25] Yang Xuefeng, Zhang Yingjun, Liu Wen, Zhu Feixiang, Ship behavior recognition based on infrared video analysis in a maritime environment, College of navigation Dalian Maritime University, DMU Dalian, China, 2015.

About Author (s):



I am G.A. Amil Dilshan Perera, an undergraduate of Faculty of Information Technology, University of Moratuwa, Sri Lanka, reading for Honors Degree of Bachelor of Science in Information Technology.



K. A. Dilini T. Kulawansa
Senior Lecturer
Department of Computational Mathematics, Faculty of Information Technology,
University of Moratuwa., Sri Lanka.